



Noisecom Products

Noisecom has been a leading provider of RF & Microwave noise generating equipment used in commercial and military applications since 1985. We provide noise diodes, built-in-test modules (BITE), calibrated noise sources, jitter sources, cryogenic noise standards, and computer controlled instruments that provide either Precision C/N, or broad band white Gaussian noise. Our additive white Gaussian noise can be used for signal jamming and impairment, or calibration. We offer high power broad

band noise to interfere with communication signals, and instruments that gradually change SNR using Gaussian, high crest factor noise to determine the robustness of a receiver.

Noisecom manufactures calibrated noise sources from audio to millimeter wavelengths in coaxial or waveguide modules that can be used for instrument calibration or noise figure test systems.

Noise Generating Instruments

- CNG-EBNO Precision Signal-to-Noise Generator
- UFX7000A Series Noise Generators
- J7000A Series Jitter Noise Generators
- DNG7500 Digital Noise Generator
- NC6000A/8000A Manual Bench Top Noise Generators

Products by Application

- Noise Figure
- Satellite Channel Impairment
- Jitter
- Antenna Reference Sources
- Basic Diode Circuit & Power Calculations

Cryogenic Noise Standard

- NBS Series Primary Noise Standard

Noise Generating Components

Calibrated Sources

- NC346 Coaxial Series
- NC346 Waveguide Series
- NC3000 Coaxial Series
- NC3200 Coaxial Series
- NC3400 High ENR Coaxial Series
- NC5000 Millimeter Wave Series
- 60 GHz Noise Figure Test Set

High Power Modules

- NC1000 Series

Circuit Board Components

- NC500/500SM Built-in-Test Series
- NC2000/4000 Amplified Multi-pin Modules

Diodes

- NC100/200/300/400 Series



A Word About Customization

Many of our customers integrate Noisecom products into their test systems. To keep costs down and avoid long lead times we have created products with modular characteristics that provide highly repeatable results. Beginning with our modules and ending with our instruments, Noisecom can provide customized units to simplify the integration process.

The amplified noise module is the basic building block of our product line. The standard module provides AWGN (additive white Gaussian noise) with a variety of power levels and noise bandwidths. The noise bandwidth and power output can be configured for high power, high crest factor, or a specific filter response. Optional control lines for switching paths and changing attenuation with either single ended, or differential outputs are possible. Our NC6000A/8000A bench top units can deliver high power over wide bandwidths with manual attenuator control for fast accurate noise testing.

The UFX, PNG, and J7000A series computer controlled instruments can provide multiple AWGN, or CW sources, internal combiners, RF path filters, RF switching, precision digital attenuation down to 0.1dB attenuation step size, and high power up to 40 GHz. The DNG7500 digital noise generator begins with 70MHz of pseudorandom noise, but can be up-converted with internal or external mixers to 2GHz. Our modular designs allow for repeatable performance without excessive cost or delayed lead times.

For more information about product options, or more detail about custom solutions please see our website at www.noisecom.com, or contact your local WTG salesperson.



Noisecom CNG-EBNO

A Fully Automated Precision Signal to Noise Generator

The instrument sets, and maintains a highly accurate ratio between a user supplied carrier and internally generated noise, over a wide range of signal power levels and frequencies. The internal power meter provides repeatable SNR waveforms for accurate signal generation.

The instrument gives system, design, and test engineers in the telecommunications industry a single tool to generate precision signal to noise ratios. These signals are used to compare theoretical BER to SNR ratios, found in “waterfall” type graphs, with measured values from the DUT to evaluate different modulation schemes. Users can obtain higher yield through automated testing, plus increased confidence from repeatable, accurate test results. Standard units can be modified for specific customer requirements. Please consult the factory for pricing and availability.

Features and Benefits:

- C/N carrier to noise ratio
- C/I carrier to interferer ratio
- C/No carrier to noise density ratio
- Eb/No bit energy to noise density ratio
- Custom configurations
- 6.5” color TFT touch screen
- Accuracy of 0.2 dB RSS
- Bit Rates from 1 bps to 1 Gbps
- Variable Output Power from -55 dBm to +5 dBm

Specifications:

Carrier Path

Input power range :	-55 dBm to +5 dBm
Maximum input power:	+21 dBm (with no damage)
Output power range:	-55 dBm to +5 dBm

Noise Path

Output power range:	-55 dBm to +5 dBm
Ratio accuracy:	±0.2 dB RSS, ±0.3 dB WCU
Power meter range:	-55 dBm to +5 dBm
Power meter accuracy:	±0.5 dB

Frequency Range: From baseband up to 22 GHz

Custom frequency bands available upon request

Primary Power

Operating Temperature:	0° to 50° C
Dimensions:	17” W x 5.25” H x 17.5” D

CNG-EBNO

Model	Frequency	Applications
CNG-EbNo-5	1 to 10 MHz	Baseband
CNG-EbNo-45	5 to 90 MHz	General Purpose
CNG-EbNo-70	50 to 90 MHz	General purpose/SATCOM
CNG-EbNo-IF1	50 to 90 MHz	Intelsat, SATCOM
	100 to 180 MHz	
CNG-EbNo-IBS/IDR	50 to 90 MHz	Intelsat, SATCOM
	68 to 72 MHz	
	100 to 180 MHz	
CNG-EbNo-225	50 to 400 MHz	General Purpose
CNG-EbNo-255	240 to 270 MHz	SATCOM
CNG-EbNo-370	350 to 390 MHz	NASA TDRSS
CNG-EbNo-CATV	50 to 860 MHz	Cable TV, HDTV
CNG-EbNo-900	800 to 1000 MHz	Cellular
CNG-EbNo-750	650 to 850 MHz	Iridium, LTE
CNG-EbNo-892	822 to 962 MHz	Cellular
CNG-EbNo-892/1850	822 to 962 MHz	Cellular
	1710 to 1990 MHz	PCS
CNG-EbNo-1550	950 to 2150 MHz	L-band modems, Satellite IF Loopback Testing
CNG-EbNo-1545	1530 to 1560 MHz	Inmarsat
CNG-EbNo-1850	1710 to 1990 MHz	J-STD-008 (CDMA) 3G Mobile Telecom
CNG-EbNo-2050	1900 to 2200 MHz	Wideband CDMA
CNG-EbNo-2050L	1700 to 2400 MHz	Cellular/PCS
CNG-EbNo-2105	1710 to 2500 MHz	3G Mobile Telecom, CDMA Wireless local loop
CNG-EbNo-2442	2400 to 2484 MHz	802.11b Wireless LAN WiFi, Bluetooth
CNG-EbNo-2450	2200 to 2700 MHz	PCS
CNG-EbNo-5500	5000 to 6000 MHz	802.11a Wireless LAN
CNG-EbNo-WiMAX	3400 to 5800 MHz	802.16 WiMax
CNG-EbNo-20000	18 to 22 GHz	Custom frequency ranges available

Call Noisecom for custom configurations

Specification values apply after a 30 minute warmup

Option Number	Description
UEopt01	Automatic gain control to maintain constant power level
UEopt03	50 Ω input and output impedance ¹
UEopt04	RS-232C, RS-422, or RS-423 interface ²
UEopt05	230 VAC, 50 Hz
UEopt15	19" rack mount
UEopt16	GPIB
UEopt17	Removable hard drive ³

¹ Below 800 MHz, standard impedance is 75 Ω . Above 800 MHz, 50 Ω is assumed.

² In addition to standard TCP/IP

³ Recommended for secure facilities



UFX7000A Series

A Remote Control Instrument with Flexible Architecture

The UFX7000A series instrument provides broadband Gaussian noise with superior flatness across the entire noise band. The standard models provide different noise bands and output power levels, but can be attenuated up to 127 dB in 1 dB steps with a choice of several different connector types. The flexible architecture allows for an optional internal combiner, 0.1 dB attenuation step size, and 4 separate filter paths. The filter paths can be either internal, or have external connections. The instruments can be modified for specific requirements, but the factory should be consulted for pricing and availability.

Features and Benefits:

- Type N, BNC, or SMA connectors available
- 127 dB attenuation in 1 dB, or optional 0.1 dB steps
- Units > 2GHz have 79.9 dB total attenuation
- Optional signal path attenuators
- SP6T switch allows four internal/external filter paths
- Band pass, low pass, high pass, or notch filters available (consult factory)
- Standard Ethernet, or optional GPIB remote control
- Optional rear panel connectors

Specifications:

Output	White Gaussian noise
Noise Bands	up to 40 GHz
Output power	up to +30 dBm
Attenuation	127 dB of attenuation; 1 dB step size Optional 0.1 dB step size Units > 2 GHz have total attenuation of 79.9 dB Low distortion signal path
Standard connectors	SMA female
Display	6.25" color VGA, TFT touch screen
Dimensions:	17.22 in. wide x 6.30 in. including feet, high x 19.5 in. deep Fold-down feet for bench top use Power 115 VAC, 60 Hz
Operating Temperature:	-10° to +65°C

UFX7000A Series

Output Characteristics

Model	Frequency Band	Power	dBm/Hz (dBm)	Flatness (dB)	uV/root (Hz)
UFX7101A	10 Hz - 20 kHz	+13	-30	±0.5	7071
UFX7103A	10 Hz - 500 kHz	+13	-44	±0.5	1414
UFX7105A	10 Hz - 10 MHz	+13	-57	±0.5	316
UFX7107A	100 Hz - 100 MHz	+13	-67	±0.75	100
UFX7108A	100 Hz - 500 MHz	+10	-77	±1.0	31.6
UFX7109A	100 Hz - 1 GHz	+10	-80	±1.5	22.4
UFX7110A	100 Hz - 1.5 GHz	+10	-82	±1.5	18.2
UFX7111A	1 GHz - 2 GHz	+10	-80	±1.5	22.4
UFX7112A	1 MHz - 2 GHz	0	-93	±2.0	5.01
UFX7113A	10 MHz - 3 GHz	0	-95	±2.5	5.01
UFX7124A	2 GHz - 4 GHz	-10	-103	±2.0	1.58
UFX7126A	2 GHz - 6 GHz	-14	-110	±2.5	0.71
UFX7128A	10 MHz - 10 GHz	-17	-117	±3.5	0.3251
UFX7218A	2 GHz - 18 GHz	-20	-122	±2.0	0.18
UFX7240A	2 GHz - 40 GHz	-20	-126	±4.0	0.11

UFX7900A Series (1 Watt output)

Output Characteristics

Model	Frequency Band	Power	dBm/Hz (dBm)	Flatness (dB)
UFX7903A	500 Hz - 500 kHz	+30	-27	±2
UFX7905A	500 Hz - 10 MHz	+30	-40	±2
UFX7907A	250 kHz - 100 MHz	+30	-50	±2
UFX7908A	1 MHz - 200 MHz	+30	-53	±2
UFX7909A	1 MHz - 300 MHz	+30	-55	±2
UFX7910A	2 MHz - 500 MHz	+30	-57	±2
UFX7911A	5 MHz - 1 GHz	+30	-60	±3

Option Number	Description
U7opt01	N female output connector
U7opt02	BNC female output connector
U7opt03	0 to 127.9 dB noise attenuator in 0.1 dB steps instead of 127 dB in 1 dB steps ¹
U7opt04	Switch elements, 2 X SP6T for 4 filter paths, 1 thru-path, 1 termination (filters optional)
U7opt06	75 Ohm output impedance (6 dB loss in the noise path and 12 dB loss in the signal path)
U7opt07	Combiner for input signal (6 dB loss in noise and signal paths)
U7opt08	Double output terminals (switched)
U7opt09	Custom frequency, power, or flatness requirement ³
U7opt10	Line power 230 VAC, 50 Hz
U7opt11	RS-232 interface
U7opt12	0 to 127 dB signal attenuator in 1 dB steps ²
U7opt13	0 to 127.9 dB signal attenuator in 0.1 dB steps ^{1 2}
U7opt15	Optional 19" rack mount brackets
U7opt16	GPIB IEEE-488
U7opt17	Removable storage media security option ⁴

¹ N/A for UFX7218A and UFX7240A (0 to 79.9 for UFX7124A and UFX7126A)

² Requires opt7, signal combiner

³ Consult factory for pricing and availability

⁴ Highly recommended for military



J7000 Jitter Noise Generator

High Crest Factor Output for Serial Data Bus Applications

These instruments are designed for most serial data applications including PCI Express, Serial ATA, and 10GigE, but can be used for any random jitter noise application. The random nature of the output is designed to model real world electrical noise commonly found in digital electrical circuits. There are several standard units with various frequency bands, but the same power level for noise output with high crest factor, typically $> 7\sigma$. The noise output is tuned for superior flatness and the signal path has a nominal insertion gain with very low amplitude and phase ripple. Standard units can be modified for specific customer requirements. Please consult the factory for pricing and availability.

Features and Benefits:

- Serial Data sources and specialized filters available (consult factory)
- Provides > 18 dB crest factor ($\pm 7\sigma$)
- 127 dB attenuation in 1 dB, or optional 0.1 dB steps
- Units > 2 GHz have 79.9 dB total attenuation
- Summing input for CNR, or E_b/N_0 measurements
- Standard Ethernet, or optional GPIB remote control
- Optional rear panel connectors

Specifications

Output noise power	-3 dBm (± 0.5 dBm)
Noise attenuation	0 to 63 dB in 0.1 dB steps up to 2 GHz
Noise attenuator	± 0.2 dB or 0.5%
Signal path gain	0 ± 1 dB
Standard connectors	SMA female
Dimensions:	17.22 in. wide x 6.30 in. including feet, high x 19.5 in. deep
Power	115 VAC, 60 Hz
Operating Temperature:	-10° to $+65^\circ\text{C}$
6.25" color VGA, TFT touch screen	
Fold-down feet for bench top use	
Ultra-low distortion signal path	

J7000A Series

Output Characteristics

Model	Frequency Band	Power (dBm)	Vrms	dBm/Hz	Flatness (dB)
J7105A	1 MHz - 10 MHz	-3	0.16	-73	±0.25 / 40 MHz
J7107A	10 MHz - 100 MHz	-3	0.16	-83	±0.25 / 40 MHz
J7108A	10 MHz - 500 MHz	-3	0.16	-90	±0.25 / 40 MHz
J7109A	10 MHz - 1 GHz	-3	0.16	-93	±0.25 / 40 MHz
J7112A	10 MHz - 2 GHz	-3	0.16	-96	±0.25 / 40 MHz
J7115A	10 MHz - 5 GHz	-3	0.16	-100	±2.5 dB

Option Number	Description
Jopt01	BNC Female input and output
Jopt02	75 ohms input and output impedance
Jopt03	230 VAC, 50 Hz
Jopt04	Switch up to 5 filter inputs
Jopt05	127 dB signal attenuator in 1 dB steps
Jopt06	DC coupled signal path (6 dB RF Loss)
Jopt07	IEEE-488 interface remote control
Jopt08	Optional 19" rack mount brackets
Jopt09	Custom frequency, power or flatness requirement*
Jopt10	Differential Outputs*
Jopt11	Serial data filter options* <ul style="list-style-type: none"> -PCI Express GEN & GENII -Serial ATA GENI

*consult factory for specifications and pricing

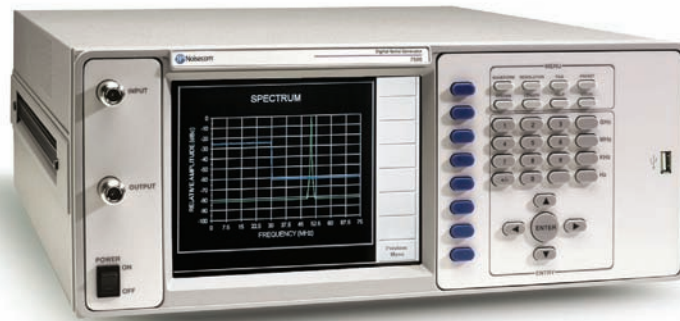

DNG7500 Digital Noise Generator

Generates Pseudo-Random Noise and CW Signals for RF, Microwave, and Digital Applications

It can provide up to a 70 MHz wide RF output to emulate real-world noise and interference conditions. The user can create many complex waveforms, including digital notches, and burst pattern waveforms in the frequency domain. The large 8.4" color display contains unit block diagrams and tabular signal parameter values making the creation and storage of waveforms intuitive and efficient. The signals can be up-converted to your band of interest with an optional Local Oscillator and mixer. User created MatLAB data files can be imported for digital conversion and subsequent analog signal output. An optional dual channel output allows for cost effective ATE test systems.

Features and Benefits:

- Digitally simulated AWGN with user settable parameters
- Program noise band frequency, power level, and notch depth
- Import user created MatLAB data files for digital conversion
- Optional Dual channels for independent signal output
- Standard GPIB, IEEE-488, remote interface
- Optional Ethernet remote control interface

RF Output

- Frequency Range 500 kHz to 70 MHz
- Minimum frequency resolution 1 Hz
- Minimum CW frequency 1 KHz
- Output Bandwidth 70 MHz
- Output Power 0 dBm
- Output Attenuator 63.9 dB in 0.1 dB steps
- Impedance 50 Ohms
- VSWR 1.5:1
- Output Connector Type N
- Harmonically Related Spurs -60 dBc typical
- Non-harmonic Spurs -60 dBc typical <50MHz
- -55 dBc typical <60MHz
- -50 dBc typical >60MHz

General

- Hard Drive
- Display 8.4" TFT-LCD 640x480 resolution
- Operating System Windows XP Pro
- Remote Ethernet or GPIB



Waveform edit screen

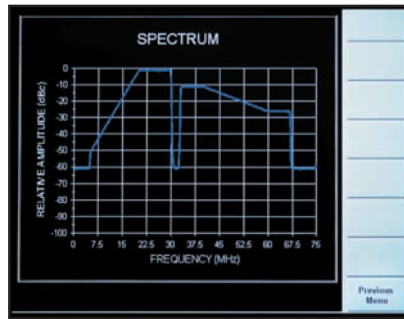

Predicted Spectral Plot

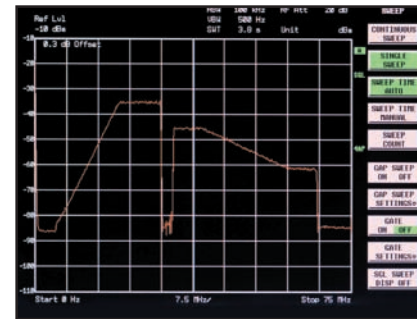

Actual waveform displayed on spectrum analyzer

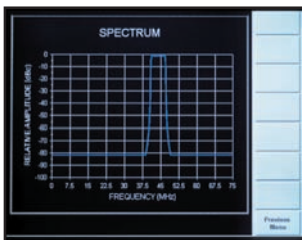

Custom pseudo noise generation with precise bandwidth.

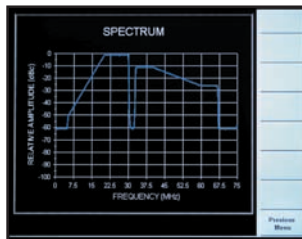

Noise Power Ratio Testing

Programmable noise bandwidth, notch bandwidth & frequency.
 Custom frequency conversion & automated NPR measurement systems available.

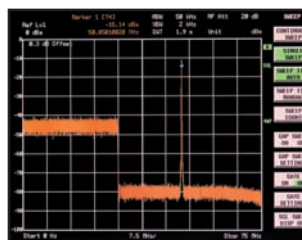

Satellite Communications

Noise and interference

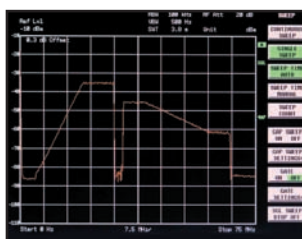

CATV

- Test this equipment against every possible noise & interference
- Upstream Interference. Cable Modem Termination (CMTS) System, Noise and interference testing
- Return Path monitoring systems testing - Creates interfering spectrums including shaped noise, ingress, signals & bursts
- Loading signals for Optical Transmit Lasers
- A/D Converter Characterization



NC6000A/8000A Series

The NC6000/8000A Series Noise Generators are Manually Operated for the RF Benchtop

Designed for General-Purpose Broadband Noise Applications on the Bench, or in a Rack Test Station. The manual controls make it simple to operate with reduced test set up time. Standard units can be modified for specific customer requirements. Please consult the factory for pricing and availability.

Features and Benefits:

- Additive White Gaussian Noise (AWGN)
- Manual attenuator
- BER testing, and SNR applications
- Secure signal jamming
- Military applications
- Custom configurations available (consult factory)

Specifications:

Output	White Gaussian noise
Manual Attenuator range	0 to 10 dB in 1 dB steps
Optional Attenuation	100 dB attenuator in 10 dB steps
Optional Attenuation	1 dB attenuator in 0.1 dB steps
Impedance	50 Ohms
Typical VSWR	1.5:1
Standard connector	SMA female (K female for NC6226)

Dimensions:

- (NC6000A) 8.5 in. wide x 5 in. high x 12.25 in. deep
- (NC8000A) 17 in. wide x 5.25 in. high x 13 in. deep

Power Requirements are 120 VAC, 60 Hz, at

- 500 mA for the NC6000A, 1500 mA for the NC8000A
- Operating temperature -10° to + 60°C



NC6000A

Output Characteristics

Model	Frequency Band	Power	PSD dBm/Hz	Flatness (dB)	uV/root (Hz)
NC6101A	10 Hz-20 kHz	+13	-30	±0.5	7071
NC6103A	10 Hz-500 kHz	+13	-44	±0.5	1414
NC6105A	10 Hz-10 MHz	+13	-57	±0.75	316
NC6107A	100 Hz-100 MHz	+13	-67	±1.0	100
NC6108A	100 Hz-500 MHz	+10	-77	±1.5	31.6
NC6109A	100 Hz-1 GHz	+10	-80	±2.0	22.4
NC6110A	100 Hz-1.5 GHz	+10	-82	±2.0	18.2
NC6111A	1 GHz-2 GHz	+10	-80	±2.0	22.4
NC6112A	1 MHz-2 GHz	0	-93	±2.5	5.01
NC6124A	2 GHz-4 GHz	-10	-103	±2.5	1.58
NC6126A	2 GHz-6 GHz	-15	-111	±2.5	0.63
NC6218A	2 GHz-18 GHz	-20	-122	±3.0	0.18
NC6226A	2 GHz-26.5 GHz	-20	-124	±3.0	0.14

*High power units have a reduced crest factor.

NC8000A

Output Characteristics

Model	Frequency Band	Power (dBm)	PSD dBm/Hz	Flatness (dB)
NC8103A*	500 Hz-500 kHz	+30	-27	±2.0
NC8105A*	500 Hz-10 MHz	+30	-40	±2.0
NC8107A*	250 kHz-100 MHz	+30	-50	±2.0
NC8108A*	1 MHz-200 MHz	+30	-53	±2.0
NC8109A*	1 MHz-300 MHz	+30	-55	±2.0
NC8110A*	2 MHz-500 MHz	+30	-57	±2.0
NC8111A*	5 MHz-1 GHz	+30	-60	±2.5

Option Number	Description
NC6/NC8opt01	100 dB attenuator in 10 dB steps*
NC6/NC8opt02	110 dB attenuator in 1 dB steps (two attenuators)**
NC6/NC8opt03	Line power 230 VAC, 50 Hz
NC6/NC8opt04	Combiner for input signal (6 dB loss in noise and signal paths)
NC6opt06	19 in. Rack mount (NC6000 only) 17 in. wide by 3.5 in. high by 13 in. deep
NC6/NC8opt07	N female output connector
NC6/NC8opt08	BNC female output connector
NC6/NC8opt09	75-ohm output impedance (6 dB loss)
NC6/NC8opt10	Additional 1 dB attenuator in 0.1 dB steps***
NC6/NC8opt11	Custom frequency, power, or flatness requirement****

*60 dB for NC6124A, NC6218A, and NC6226A

**69 dB for NC6124A, NC6218A, and NC6226A

***N/A for NC6124, NC6218, NC6226, and NC6126

****Consult factory for pricing and availability



NBS-Series Cryogenic Primary Noise Standards

Calibration Standards Based on the Primary Physic Constants of Thermal Noise and Blackbody Radiation

This provides the ultimate accuracy when measuring extremely low noise figures (noise temperatures). Simple, and versatile to use, the NBS-Series is an ideal solution for noise source calibrations, radiometer test references and low noise amplifier tests.

Features and Benefits:

- Expandable frequency range from 18 to 325 GHz
- 2 to 3 times better accuracy
- Automatic Nitrogen purge eliminates pressurized helium equipment
- Primary calibration standard
- Radiometer reference source
- SATCOM earth station conformance verifications

Applications:

- Noise temperature calibrations
- Noise source calibrations
- Radiometer reference sources
- Low noise amplifier (LNA) noise figure
- (NF) measurements
- Antenna system effective input noise temperature tests
- SATCOM earth station conformance verifications

High Power Modules 50 Ω Load Impedance (Package 1, +28 VDC Operation is standard)

Model	Frequency Range (GHz)	Output Noise Temperature (K)	Temperature Accuracy (K)	Waveguide
NBS-26	18.0 - 26.5	75.97	+0.24/-0.34	WR-42
NBS-33	22.0 - 33.0	75.93	+0.24/-0.36	WR-34
NBS-40	26.5 - 40.0	75.98	+0.25/-0.39	WR-28
NBS-50	33.0 - 50.0	76.03	+0.27/-0.43	WR-22
NBS-60	40.0 - 60.0	76.10	+0.29/-0.47	WR-19
NBS-75	50.0 - 75.0	76.01	+0.31/-0.52	WR-15
NBS-90	60.0 - 90.0	76.00	+0.33/-0.56	WR-12
NBS-110	75.0 - 110.0	75.99	+0.37/-0.64	WR-10
NBS-140	90.0 - 140.0	76.17	+0.44/-0.77	WR-8
NBS-170	110.0 - 170.0	76.22	+0.51/-0.90	WR-6
NBS-220	140.0 - 220.0	75.99	+0.61/-1.06	WR-5
NBS-260	170.0 - 260.0	75.76	+0.68/-1.19	WR-4
NBS-325	220.0 - 325.0	75.30	+0.81/-1.40	WR-3

NC346 Broadband Coaxial

The NC346 Noise Source is designed for precision noise figure measurements using a dedicated noise figure analyzer or a spectrum analyzer with noise figure capability. The module's low VSWR increases noise figure measurement accuracy.



Features and Benefits:

- Broadband coverage
- Extremely good temperature stability
- Superior voltage stability
- Noise figure meter-compatible



Specifications:

Calibration	1 GHz steps
Temperature coefficient	< 0.009 dB/°C
Operating temperature	0°C to +55°C
Input power	+28 VDC ±2 VDC at 15 mA typical for NC346 A, B & D
VSWR	< 1.15:1 from 10 MHz – 5 GHz for units with 5 – 7 dB or 14 –16 dB ENR
Regulator	Built-in
Voltage coefficient	< 0.002 dB/%ΔV

NC346 Coaxial Series

Model	RF Connector	Frequency (GHz)	Output ENR (dB)	VSWR (maximum @ on/off)					I (max) (mA)
				0.01 - 5 GHz	5 - 18 GHz	18 - 26.5 GHz	26.5 - 40 GHz	40 - 60 GHz	
NC346A	SMA Male	0.01 - 18.0	5 - 7	1.15:1	1.25:1				30
NC346A Precision	APC3.5 Male	0.01 - 18.0	5 - 7	1.15:1	1.25:1				30
NC346A Option 1	N Male	0.01 - 18.0	5 - 7	1.15:1	1.25:1				30
NC346A Option 2	APC7	0.01 - 18.0	5 - 7	1.15:1	1.25:1				30
NC346A Option 4	N Female	0.01 - 18.0	5 - 7	1.15:1	1.25:1				30
NC346B	SMA Male	0.01 - 18.0	14 - 16	1.15:1	1.25:1				30
NC346B Precision	APC3.5 Male	0.01 - 18.0	14 - 16	1.15:1	1.25:1				30
NC346B Option 1	N Male	0.01 - 18.0	14 - 16	1.15:1	1.35:1				30
NC346B Option 2	APC7	0.01 - 18.0	14 - 16	1.15:1	1.25:1				30
NC346B Option 4	N Female	0.01 - 18.0	14 - 16	1.15:1	1.35:1				30
NC346C	APC3.5 Male	0.01 - 26.5	13 - 17	1.15:1	1.25:1	1.35:1			30
NC346D	SMA Male	0.01 - 18.0	19 - 25*	1.50:1	1.50:1				30
NC346D Precision	APC3.5 Male	0.01 - 18.0	19 - 25*	1.50:1	1.50:1				30
NC346D Option 1	N Male	0.01 - 18.0	19 - 25*	1.50:1	1.75:1				30
NC346D Option 2	APC7	0.01 - 18.0	19 - 25*	1.50:1	1.50:1				30
NC346D Option 3	N Female	0.01 - 18.0	19 - 25*	1.50:1	1.75:1				30
NC346E	APC3.5 Male	0.01 - 26.5	19 - 25*	1.50:1	1.50:1	1.50:1			30
NC346Ka	K Male**	0.10 - 40.0	10 - 17	v1.25:1	1.30:1	1.40:1	1.50:1		30
NC346V	V Male	0.10 - 55.0	7 - 21	1.50:1	1.50:1	1.75:1	2.00:1	2.50:1	30

* Flatness better than ±2 dB ** Compatible with SMA and APC3.5

NC346 Waveguide

Designed for Narrow-Band High ENR Noise Figure Measurement Applications

For high power waveguide systems the series has an optional built-in isolator to provide very low VSWR and superior flatness, typically $\leq \pm 1.5$ dB.



Features and Benefits:

- Noise figure measurement
- Built-in isolator option
- LNA receiver testing
- Radiometers



Specifications

Calibration	1 GHz steps
Temperature coefficient	< 0.009 dB/°C
Operating temperature	0°C to +55°C
Input power	+28 VDC \pm 2 VDC at 15 mA typical for NC346 A, B & D
VSWR	< 1.15:1 from 10 MHz – 5 GHz for units with 5 – 7 dB or 14 –16 dB ENR
Regulator	Built-in
Voltage coefficient	< 0.002 dB/% Δ V

Waveguide Flange Chart

Waveguide Type	DIM A(in.)	DIM B(in.)	DIM C(in.)	DIM D(in.)
WR75	5.25	1.50 SQ	.98	1.60
WR90	5.68	1.68 SQ	.72	1.50
WR229	6.02	3.87	1.10	2.09

NC346 Waveguide Series (Built-In Isolator*)

Model	Flange	Frequency (GHz)	ENR (dB)	VSWR (on/off)	I (max) (mA)
NC346B-WR229	CPR229F	3.7 - 4.2	14 - 16**	1.20:1	30
NC346B-WR90	UG39/U	8.5 - 9.6	14 - 16**	1.20:1	30
NC346B-WR75	UBR120	10.5 - 13.0	14 - 16**	1.20:1	30

*Inquire for other flanges or waveguide sizes **Flatness better than ± 0.15 dB

Connector	DIM A (in.)
SMA Male	0.50
APC 3.5 Male	0.50
N Male	1.14
APC 7	1.30
N Female	0.94
K Male	0.46
V Male	0.85

NC3000 Coaxial

Well Suited for Receiver Testing, Noise Figure Measurements, or Applications which Require Broadband Noise and Fast Switching Times

Several models include output isolators, and voltage regulators that provide excellent stability over varying temperature and voltage ranges. The NC 3000 Series includes the NC 3100 units with 15 dB ENR output for noise-figure meters, and the NC 3200 Series high output noise sources with outputs between 26 and 35 dB ENR for radar and satellite communications system testing.



Features and Benefits:

- Noise output rise and fall times less than 1 μ s
- VSWR < 1.35:1 for units with 15.5 dB ENR
- Noise output variation with temperature < 0.01dB/°C
- Noise output variation with voltage < 0.1dB/ 1% Δ V

Specifications:

Operating temperature	-55 to + 85°C
Storage temperature	-65 to 125°C
Input power	+28 VDC at 30 mA max.

15.5 dB Noise Figure Meter Compatible Types

Mode	Frequency Range (GHz)	Noise Output ENR (dB)	Maximum VSWR ON	Calibration Frequencies
NC3102-1	0.4 - 1	15.5 \pm .75	1.30:1	200 MHz steps
NC3103	1 - 12	15.5 \pm .75	1.30:1	1 GHz steps
NC3104	1 - 18	15.5 \pm .75	1.35:1	1 GHz steps
NC3105	12 - 18	15.5 \pm .75	1.35:1	1 GHz steps
NC3108	0.5 - 18	15-16 \pm 1	1.5:1	1 GHz steps

High Noise Output Types

Model	Frequency Range (GHz)	Noise Output ENR (dB)	Flatness (dB)	Calibration Frequencies
NC 3201-1	0.4 - 1	30-35	\pm 1	200 MHz steps
NC 3202-1	0.4 - 0.6	30-35	\pm 1	100 MHz steps
NC 3203	1 - 2	30-35	\pm 1	1, 1.5 & 2 GHz
NC 3204	2 - 4	30-35	\pm 1	1 GHz steps
NC 3205	4 - 8	30-35	\pm 1	1 GHz steps
NC 3206	8 - 12	28-33	\pm 1	1 GHz steps
NC 3207	12 - 18	26-32	\pm 1	1 GHz steps
NC 3208	1 - 18	26-32	\pm 1	1 GHz steps

NC3200K Coaxial Noise Sources

Offers a High ENR Output Over a Wide Frequency Range

These calibrated noise sources have excellent stability with temperature and voltage for tough environments. The compact package is designed for severe environments such as military EW Radar Warning Receivers (RWR) systems. Special configurations are available upon request.

The NC3200 Series features hermetically sealed noise diodes and each noise source is supplied with calibration data for the full frequency band.

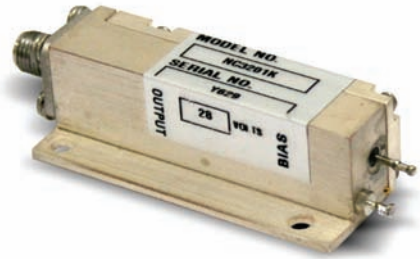

Features and Benefits:

- Noise output rise and fall times Less than 1 μ s (NC3208K)
- VSWR Less than 3:1
- Noise output variation with temperature Less than 0.01 dB/ $^{\circ}$ C
- Noise output variation with voltage Less than 0.1 dB/1% Δ V

Specifications:

Operating temperature -55 $^{\circ}$ to 85 $^{\circ}$ C

Storage temperature -65 $^{\circ}$ to +125 $^{\circ}$ C

Input power +28 VDC 20 mA typical

Noise output 23 to 27 dB ENR

High Noise Output Types

Model	Frequency Range (GHz)	Noise Output ENR (dB)	Flatness (dB)	VSWR	Calibration Frequencies	I (max)(mA)
NC 3201K	10 kHz - 1 GHz	23-27	\pm 1	3:1	10, 100, 500 and 1000 MHz	30
NC 3208K	1 GHz - 18 GHz	23-27	\pm 1	3:1	1 GHz steps	30

Option Number	Description
NC3Kopt01	+15 VDC input voltage
NC3Kopt02	MIL-STD-883 screening

NC3400 High ENR Coaxial

Excellent Choice for Applications Requiring High ENR and Immunity to Large Incident RF Power Found in Radiometer and Radar Systems

The calibration accuracy and flatness of the NC3400 Series noise sources are enhanced by their low VSWR. The built-in isolator provides almost constant output impedance as the noise source bias is switched on and off. The isolator also protects the noise diode from incident RF power (consult the factory for high power units).



An SMA female connector is standard for the RF output and a BNC female connector is standard for the bias input. Other connectors are available as options.

Applications

- Radar systems
- High NF device measurements
- Automated test equipment (ATE)

Specifications:

ENR	Up to 35 dB
VSWR	< 1.25:1
Standard input voltage	+28 VDC
Noise output rise and fall times	< 1 μ s
Maximum incident RF power	1 W average, 100 W peak
Typical current	12 to 15 mA

15.5 dB Noise Figure Meter Compatible Types

Mode	Frequency Range (GHz)	Noise Output ENR (dB)	Flatness Full band (dB)	Maximum VSWR (on/off) **	I (max)(mA)
NC3404	2 - 4	30 - 36	\pm 0.75	1.25:1	30
NC3405	4 - 8	30 - 35	\pm 0.75	1.25:1	30
NC3406	8 - 12	28 - 33	\pm 0.75	1.25:1	30
NC3407	12 - 18	26 - 32.5	\pm 0.75	1.25:1	30

* Flatness for units optimized for bandwidths less than 10 percent of the center frequency is less than \pm 0.25 dB. Improved VSWR may also be obtained for units with reduced bandwidth.

** VSWR for models with N connector is 1.35:1 up to 12 GHz. N connectors are not recommended for frequencies above 12 GHz.

NOTE: Standard calibration points are located at every 1 GHz.

Option Number	Description
NC34opt01	N male output connector
NC34opt02	SMA male output connector
NC34opt03	+15 VDC input voltage
NC34opt04	+28 VDC with regulation (stabilized output for \pm 2 V variation)
NC34opt05	TTL control "high" is on (add suffix T)
NC34opt06	SMC male bias connector
NC34opt07	Solder lug for bias connection

NC5000 Millimeter-Wave

The NC5000 Series Noise Sources Feature Outstanding Stability, Switching Speed, and Ripple-Free Response Over Standard Waveguide Bands

The high stability of the NC5000 Series allows these units to replace cumbersome gas tube noise sources for most applications. Ripple in the output has a direct effect on measurement accuracy, so Noisecom has tailored the response to minimize this ripple throughout the specified frequency range.

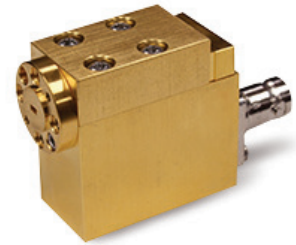

Applications:

- Noise figure measurement
- Built-in test equipment (BITE)
- Military applications
- Radiometers

Specifications:

Noise output rise and fall times	< 1 μ s
Noise output variation with temperature	< 0.01 dB/ $^{\circ}$ C
Noise output variation with voltage	< 0.1 dB/1 %AV
Operating temperature	0 to +85 $^{\circ}$ C
Input power	+28 VDC at 30 mA max

Waveguide	DIM	DIM	DIM
	A (in.)	B (in.)	C (in.)
WR15	1.78	0.76	1.96
WR10	1.50	0.76	1.70

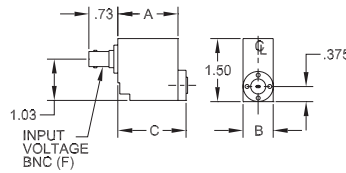

Waveguide	DIM	DIM	DIM	DIM	DIM
	A (in.)	B (in.)	C (in.)	D (in.)	E (in.)
WR42	1.72	0.88	1.44	0.44	1.38
WR28	1.55	0.75	1.30	0.38	1.20

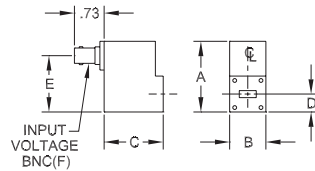

Waveguide	DIM	DIM	DIM
	A (in.)	B (in.)	C (in.)
WR22	1.51	0.75	1.31
WR19	1.51	0.75	1.31

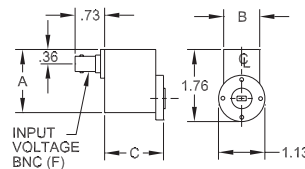

	WR42	WR28	WR22
DIM A (in.)	4.34	3.28	2.69
DIM B (in.)	1.45	1.32	1.73
	WR19	WR15	WR10
DIM A (in.)	2.63	2.56	2.46
DIM B (in.)	1.32	0.99	0.99

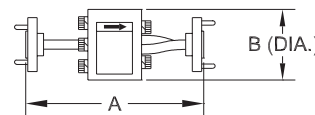

Noise Figure Meter Compatible - Full Calibration Band (1 pt / GHz)

Model	Frequency Range (GHz)	Noise Output		Typical VSWR	Mating Flange	Calibration Frequencies	Waveguide	I (max) (mA)
		ENR (dB)	Flatness (dB)					
NC5142	18 - 26.5	15.5	±0.75	1.3:1*	UG595/U	1 GHz steps	WR42	30
NC5128	26.5 - 40	15.5	±0.75	1.3:1*	UG599/U	1 GHz steps	WR28	30
NC5122	33 - 50	15.5	±1.0	1.3:1*	UG383/U	1 GHz steps	WR22	30
NC5115	50 - 75	15.5	±2.5	1.6:1*	UG385/U	1 GHz steps	WR15	30
NC5110	75 - 105	15.5	±5.5	1.6:1*	UG387/U	1 GHz steps	WR10	30

* Maximum VSWR with isolator - Option 5

High Noise Output - Full Calibration Band (1 pt / GHz)

Model	Frequency Range (GHz)	Noise Output		Mating Flange	Calibration Frequencies	Waveguide	I (max) (mA)
		ENR (dB)	Flatness (dB)				
NC5242	18 - 26.5	25.0	±1.0	UG595/U	1 GHz steps	WR42	30
NC5228	26.5 - 40	23.0	±2.0	UG599/U	1 GHz steps	WR28	30
NC5222	33 - 50	21.0	±2.0	UG383/U	1 GHz steps	WR22	30
NC5215	50 - 75	17.0	±2.5	UG385/U	1 GHz steps	WR15	30

High Noise Output - User Selected 1 GHz Calibration Band (3 pts)

Model	Frequency Range GHz	Noise Output		Mating Flange	Calibration Frequencies	Waveguide	I (max) (mA)
		ENR (dB)	Flatness (dB)				
NC5342	18 - 26.5*	25.0	±0.5	UG595/U	Minimum Center And Maximum	WR42	30
NC5328	26.4 - 40*	23.0	±0.5	UG599/U		WR28	30
NC5322	33 - 50*	21.0	±0.5	UG383/U		WR22	30
NC5315	50 - 75*	17.0	±0.7	UG385/U		WR15	30
NC5310	75 - 110*	11.0	±0.7	G387/U		WR10	30

* Bandwidths of 1 GHz may be specified anywhere in the band. Other bandwidths may be specified. However, wider bandwidths may result in a different flatness specification.

60 GHz Noise Figure Test Set

Four Configurations for Flexibility when Performing Y-factor Noise Figure Measurements with Spectrum Analyzer or Dedicated Receiver

Each system contains a highly stable V-band noise source, isolator(s), optional waveguide to coaxial transitions and an optional pre-amplifier for use with a spectrum analyzer. The two standard calibration tables have ENR data points at 1 GHz intervals. System ENR is measured before the DUT connector and at the final output stage allowing for pre-test calibration of the system.



Specifications:

Noise Source

BW	50 GHz to 75 GHz
Power output	17.5 dB ENR
Flatness	± 2.5 dB
Power input	28 V, BNC connector

Amplification

BW	57 GHz to 64 GHz
Power	30 dB of Gain
Final output Flatness	± 3 dB
Power input 1	2V, 160 mA, two solder lugs
Isolation	25 dB of isolation @ 60 GHz

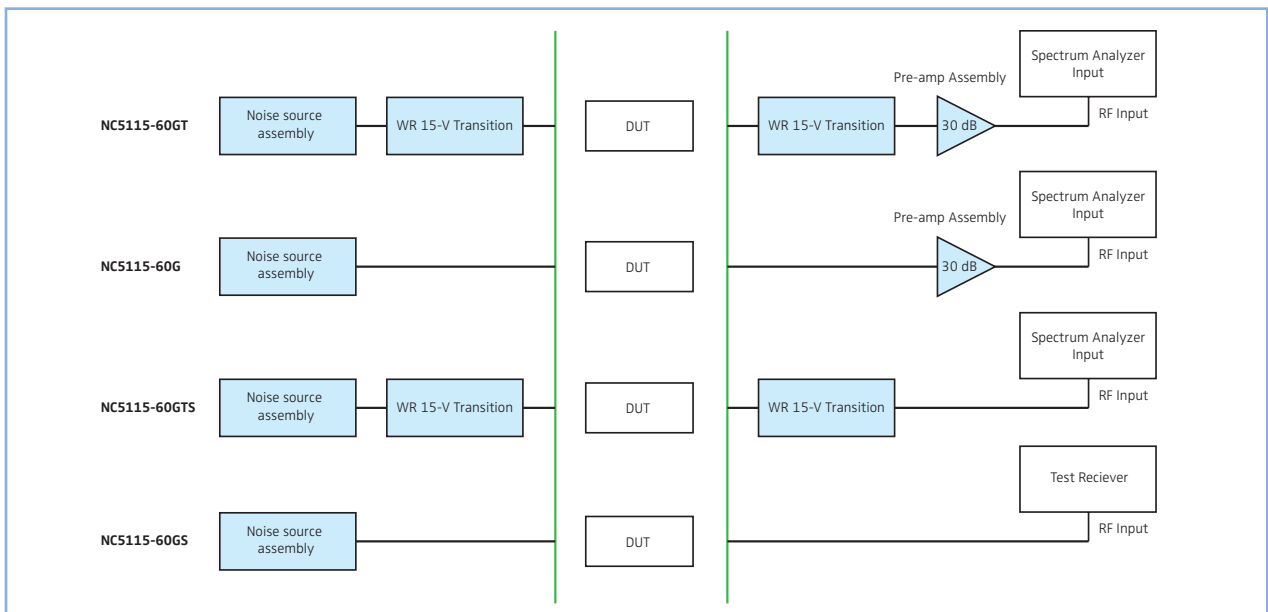

NC1000 Series Amplified Noise Modules

Amplified Noise Modules with AWGN up to +13 dBm, and Bandwidths Up to 10 GHz

The high power modules are designed to test noise immunity for Cable TV equipment, secure communication channels, and military jamming systems. The lower power modules, ≤ 0 dBm, are random jitter sources for many applications including, PCIeexpress, Infiniband, and 10 GigE. The Bandwidth, output power, and flatness can be modified for specific applications. A newly developed TTL controlled attenuation feature and differential outputs are available options.



Applications:

- 10 GbE
- IEEE 802.3
- Infiniband
- PCIeexpress
- CATV
- Jamming systems

Specifications:

Power	Up to +13 dBm
Standard input Voltage	+28VDC (below 1.5 GHz) +15 VDC (above 1.5 GHz)
Operating temperature	-35° to +100°C
Storage temperature	-65° to +150°C
Typical temperature coefficient	0.025 dB/°C
Supply voltage sensitivity	0.25 dB/1%ΔV
Output connector	SMA female connector

High Power Modules

Model	Frequency Range	Output Characteristics				I (max) (mA)
		Power (dBm)	dBm/Hz	Flatness (dB)	$\mu\text{V}/\Delta\text{Hz}$	
NC1101A	10 Hz - 20 kHz	+13	-30	± 0.5	7071	70
NC1103A	10 Hz - 500 kHz	+13	-44	± 0.5	1414	150
NC1105A	10 Hz - 10 MHz	+13	-57	± 0.75	316	160
NC1107A	100 Hz - 100 MHz	+13	-67	± 1.0	100	160
NC1108A	100 Hz - 500 MHz	+10	-77	± 1.5	31.6	160
NC1109A	100 Hz - 1 GHz	+10	-80	± 2.0	22.4	160
NC1110A	100 Hz - 1.5 GHz	+10	-82	± 2.0	18.2	160

High Crest Factor Modules

Model	Frequency Range	Output Characteristics				I (max) (mA)
		Power (dBm)	dBm/Hz	Flatness (dB)	$\mu\text{V}/\Delta\text{Hz}$	
NC1111A	1 GHz - 2 GHz	-10	-100	± 2.0	2.24	250
NC1111B	1 GHz - 2 GHz	0	-90	± 2.0	7.07	250
NC1112A	20 MHz - 2 GHz	-10	-103	± 2.5	1.58	250
NC1112B	20 MHz - 2 GHz	0	-93	± 2.5	5.02	250
NC1113A	10 MHz - 3 GHz	-10	-105	± 2.5	1.12	250
NC1113B	10 MHz - 3 GHz	0	-95	± 2.5	5.02	250
NC1124A	2 GHz - 4 GHz	-10	-103	± 2.5	1.58	250
NC1126A	2 GHz - 6 GHz	-14	-110	± 2.5	0.71	250
NC1128A	10 MHz - 10 GHz	-17	-117	± 3.0	0.32	250

NC500/500SM Series BITE Modules

The NC500 (Through-Hole) and 500SM (Surface Mount) Series Noise Modules are an Economical Solution for Built-in Test Requirements

They contain complete bias circuits and require no external components. Some models contain additional gain stages for high power ENR output (51 dB). The surface mount package is suitable for mounting on micro strip. The modules have extremely flat output power versus frequency characteristics that are insensitive to temperature and voltage variations.

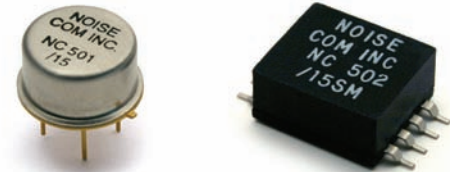

Applications

- Built-in test equipment (BITE)
- Signal strength meters for cellular, PCS and CATV
- Calibrators
- Spectrum analyzers
- Radar warning receivers (RWR)
- Dither A/D quantization error
- Gain-bandwidth product testing

Specifications:

Output	White Gaussian noise
Minimum power output	31 dB ENR (-143 dBm/Hz) 51 dB; ENR (-123 dBm/Hz)
Crest factor	5:1
Supply current	0.2 to 5 mA (NC500 Series) 10 to 20 mA (NC510 Series)
Temperature coefficient	0.01 dB/°C
Supply sensitivity	0.1 dB/% ΔV
Operating temperature	0° C to +70° C (surface mount) -55° C to 85° C (drop-in/through-hole)
Storage temperature	-65° to +150° C
Packaging	Through-hole or surface mount
Power	+12, +15 V or +28 V
Absolute maximum input voltage	+30 V for +15 V models +40 V for +28 V models

Model For +12 V Supply	Model For +15 V Supply	Model For +28 V Supply	Frequency Range	Minimum Output ENR (dB) @ R _i (Ω)		Output Flatness (dB)	I (Max) (mA)
NC501/12	NC501/15	NC501	200 kHz - 500 MHz	31	50	±0.5	10
NC502/12	NC502/15	NC502	200 kHz - 1 GHz	31	50	±1.0	10
NC503/12	NC503/15	NC503	200 kHz - 2 GHz	31	50	±1.5	10
NC504/12	NC504/15	NC504	200 kHz - 3 GHz	31	50	±1.5	10
NC505/12	NC505/15	NC505	200 kHz - 4 GHz	31	50	±2.0*	10
NC506/12	NC506/15	NC506	200 kHz - 5 GHz	31	50	±2.5*	10
NC511/12	NC511/15	N/A	200 kHz - 500 MHz	51	50	±2.0	30
NC512/12	NC512/15	N/A	200 kHz - 1 GHz	51	50	±2.0	30
NC513/12	NC513/15	N/A	200 kHz - 2 GHz	51	50	±2.0	30

1. Military version in compliance with MIL-E-5400T Class 2 (add suffix M). Not available in surface mount, NC501 to NC506 Series only.

2. Add SM for surface mount. Otherwise TO-8 is standard.

* Flatness ±4.0 for SM Series of these models.

NC2000/4000 Series Broadband Amplified Noise Modules

An Excellent Choice for High-Level Noise Modules Mounted on a Circuit Board

The NC2000 Series modules are housed in 24, or 14-pin dual-inline packages. The NC4000 series modules are housed in a 40-pin module that cover similar noise bands to the NC2000, but have higher crest factor, and 60 dB of TTL controlled attenuation. Modified BW, output power, and flatness specifications are available for these modules. Please consult Noisecom for availability, and appropriate package style.



Applications:

- Dither circuitry for A/D converters
- Communications jamming
- Jitter applications including PCIe, 10GigE, & SATA
- Built-in test equipment (BITE)

Specifications:

Crest factor	5:1
High-end roll off	6 dB per octave typical
Operating voltage	+15 VDC, +12 VDC optional
Storage temperature	-65° to +125°C
Operating temperature	Commercial -40° to +85° C; Military -55° to +125° C
Typical temperature coefficient	0.025 dB/° C
Housing	24-pin packages; 14-pin optional
Noise output	23 to 27 dB ENR

Model	Frequency Range	Output Characteristics				Load Ω	I (max) (mA)
		Output Level	Flatness (dB)	dBm/Hz	μ V/Hz		
NC2101	100 Hz - 20 kHz	0.150 Vrms	± 0.75	-63	1061.0	2200	10
NC2102	100 Hz - 100 kHz	0.150 Vrms	± 0.75	-70	474.0	2200	10
NC2105	500 Hz - 10 MHz	0.150 Vrms	± 1.0	-87	47.4	1000	10
NC2201*	1 MHz - 100 MHz	+5 dBm	± 0.75	-75	40.0	50	100
NC2401*	1 MHz - 500 MHz	0 dBm	± 1.0	-87	10.0	50	100
NC2501*	1 MHz - 1 GHz	-5 dBm	± 1.0	-95	4.0	50	100
NC2601*	1 MHz - 2 GHz	-5 dBm	± 2.0	-98	2.8	50	100

*Crest factor is 2:1 for these models

NC100/200/300/400 Series Chips and Diodes

The Fundamental Building Blocks for Analog Noise

Noisecom noise diodes are categorized by their noise output and special response. The NC100/NC200 series diodes are designed for audio and RF applications, while the NC300/NC400 series are designed for microwave applications.

Noisecom noise diodes can deliver symmetrical white gaussian noise with a flat output power, but performance may vary depending on circuit design.

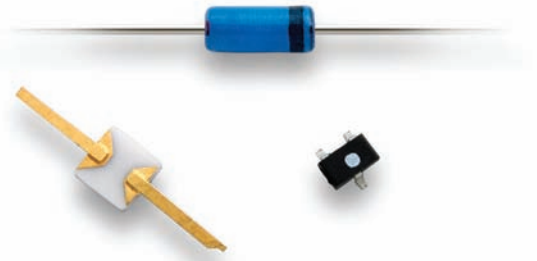

Features and Benefits:

- Custom electrical testing available upon request
- Wide package variety with custom configurations
- NC100 & 200 series for audio and RF applications
- NC300 & 400 series for microwave applications

Specifications:

Output	White Gaussian Noise
Operating temperature	0°C to +55°C temperature for NC100 series; -55°C to +125°C for all others
Storage temperature	-65°C to +150°C

Audio & VHF Types

Model	Frequency Range	Operating Conditions			Minimum Output ($\mu\text{V}/\sqrt{\text{Hz}}$)	Package
		V_b (V)	I_{op}	R_L (Ω)		
NC101	0.1 Hz - 100 kHz	7 - 10	30 - 60 μA	2200	3.0	DO-35
NC102	0.1 Hz - 500 kHz	7 - 10	30 - 60 μA	2200	3.0	DO-35
NC103	0.1 Hz - 1 MHz	7 - 10	30 - 60 μA	2200	3.0	DO-35
NC104	0.1 Hz - 3 MHz	7 - 10	30 - 60 μA	2200	3.0	DO-35
NC201	0.1 Hz - 10 MHz	7 - 10	0.2 - 0.5 mA	2200	0.1	DO-35
NC202	0.1 Hz - 25 MHz	7 - 10	0.2 - 0.5 mA	2200	0.1	DO-35
NC203	0.1 Hz - 100 MHz	7 - 10	0.2 - 0.5 mA	50	0.05	DO-35

RF & Microwave Types

Model	Frequency Range	Operating Conditions			Output ENR (dB)	Package
		V_b (V)	I_{op} (mA)	R_L (Ω)		
NC302L	10 Hz - 3 GHz	6 - 8	6	50	30 - 35	DO-35, BL, CH1
NC303	10 Hz - 8 GHz	8 - 12	8	50	30 - 35	DO-35, BL, CH1
NC303SOT	10 Hz - 8 GHz	8 - 10	8	50	30 - 35	SOT323
NC305	10 MHz - 11 GHz	8 - 12	10	50	29 - 34	BL, CH1
NC401	100 MHz - 18 GHz	8 - 12	10	50	30 - 35	C10, C50H, CH2
NC403	100 MHz - 27 GHz	8 - 12	12	50	24 - 28	C50, CH3
NC404	18 GHz - 50 GHz	8 - 12	15	50	20 - 25	C50, CH3
NC405	18 GHz - 75 GHz	8 - 12	20	50	15 - 25	C50, CH3
NC406	18 GHz - 110 GHz	8 - 12	25	50	15 - 25	C50, CH3

1. For chip configuration, add suffix "C".
2. For beam lead configuration, add suffix "BL".
3. For C50H configuration, add suffix "H".

Products by Application

The two primary applications for white noise are signal jamming/impairment and reference level comparison. Signal jamming/impairment can be further divided into secure signal jamming and telecommunication signal impairment. Secure signal jamming requires high power broadband noise for the purpose of disrupting communication signals. Telecommunication signal impairment is a gradual change in Signal to Noise Ratio (SNR) to measure the robustness of the receiving network. This type of impairment has many coaxial and wireless applications. Digital Engineers working with PCIe, SATA, or 10GigE refer to these coaxial impairments as “Jitter”. Wireless RF Engineers working with Satellite, WiMax, or LTE communication links refer to the disturbance as “Bit energy to Noise Density (E_b/N_0) or carrier to noise ratio (C/N). In either case the noise requirements are similar. For reference level comparison, a calibrated noise source with a flat band across a large spectrum is compared to the noise floor of the instrument under test. This is typical for spectrum analyzers, but any device that requires an absolute noise floor for operation can use this method. Astro-physicists and Meteorologists also use this source as a repeatable “Hot” source reference to calibrate the antenna power level. This same noise signal is used by amplifier design engineers to calculate noise figure (NF) and gain. Using a noise source for testing is less expensive than a precision sweeping signal generator for these measurements.

Noise Figure

Noise Com’s NC346 and NC5000 calibrated noise sources are designed to be used with a Noise Figure Meter. The typical setup is shown in Figure 1. The isolator and LNA can be added to reduce measurement uncertainty. The isolator reduces reflected power between the DUT and the test setup, while the LNA reduces the noise figure of the test setup. For the wideband case, the isolator may be replaced with a low VSWR attenuator of approximately 6 to 10 dB. The test setup is first calibrated without the DUT (device under test) at the frequencies to be tested. The DUT is then connected after the noise source for a noise figure measurement.

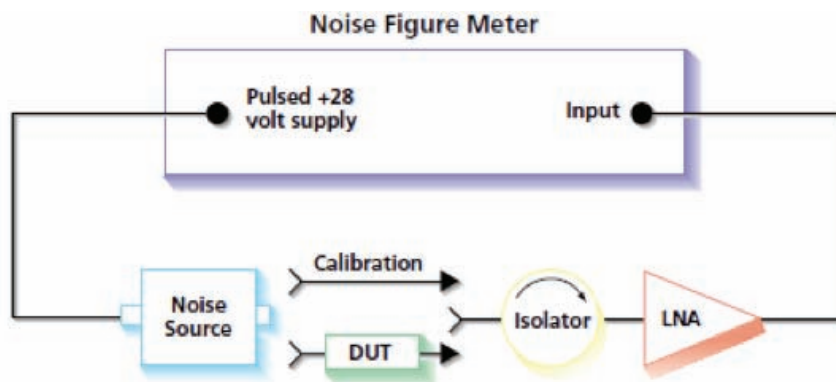

Figure 1: Noise Figure Calibration and Testing

One of the most important contributions to measurement accuracy is a good match or low VSWR ratio between the noise source output and the connected device, or DUT. During measurement, a small amount of noise power is reflected back at the DUT input (see Figure 2). Some of the reflected power is reflected again at the noise source output with unpredictable phase, changing the measured power of the signal in an uncertain way. The same holds true for the difference in mismatch between calibration setup and measurement setup. (see Fig. 2)

Minimum mismatch change from the “ON” state to the “OFF” state of the noise source is another key to measurement accuracy. The ENR for the noise source is calibrated relative to a 50Ω termination at room temperature. If the noise source changes impedance when turned on, the DUT sees a different noise power level than has been calibrated for the noise source and causes reflected and re-reflected power be incorrectly measured. The meter uses the noise source ENR calibration, along with measured data, to calculate noise figure. The accuracy of the noise figure measurement is therefore dependent on the accuracy of the noise source calibration values.

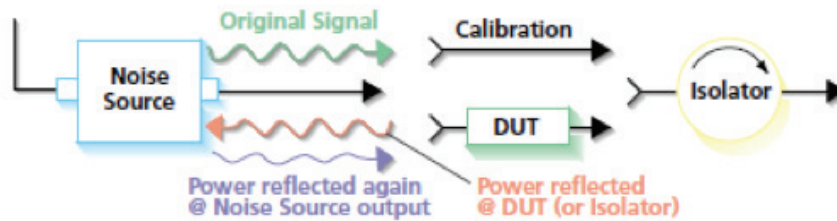

Figure 2: Impedance Mismatch Reflection Illustration

Satellite Channel Impairment: Performance of BER vs Eb/No

Figure 4 shows an example of typical satellite modem loop test designed to find the ideal performance of BER vs Eb/No. The CNG-EbNo generates a precise bit-energy to noise-density (Eb/No) ratio and the BER test equipment measures the respective bit error rate. Plotting BER vs. Eb/No in a logarithmic scale produces a waterfall-like curve. (Figure 3) The Eb/No value is commonly used with modulation and coding designed for noise-limited rather than interference-limited communication systems, and for power-limited rather than bandwidth limited communication systems. Examples of power-limited systems include spread spectrum and deep-space, which are optimized by using large bandwidths relative to the bit rate.

MSK: Minimum shift keying

PSK: Phase shift keying

DBPSK: Differential binary phase shift keying

DQPSK: Differential quadrature phase shift keying

OOK: On-off keying

OFSK: Orthogonal frequency shift keying

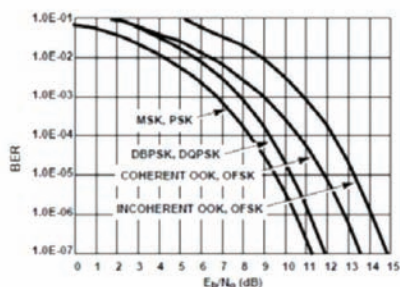

Figure 3. Example of the Relationship BER and Eb/No

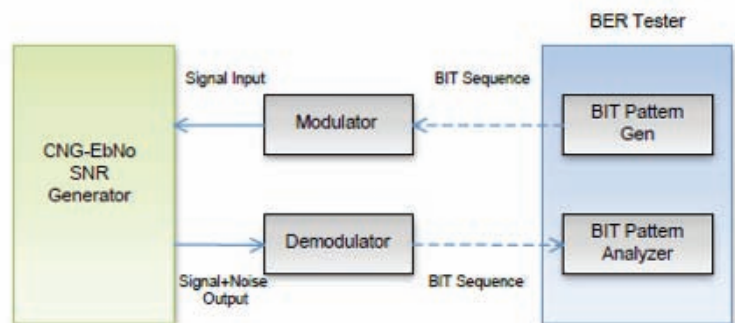

Figure 4. Block Diagram of Typical Satellite Modem Loop Test Up

Jitter in High Speed Data Devices

System Jitter can have drastic effects on circuit behavior because it can vary transition placement in time and narrow the persistence eye opening on a test receiver, usually an oscilloscope, and ultimately create a higher BER. While noise is unwanted interference, it can be used to provide precise disturbances in high speed data systems to assess interoperability among components and establish a jitter budget. True White Gaussian noise closely resembles real world interference and can be injected via passive coupling onto the amplitude axis of the data stream to create AM, or phase modulated on the time axis to cause phase deviation in terms of time (dT). Both types of jitter can be used alone, or in conjunction to cause deviation in terms of dV and dT . If generated properly, the amplitude distribution of White noise follows a bell, or Gaussian curve with a high crest factor, or large number of standard deviations, Sigma (σ). This type of noise can be added in precise amounts to digital circuits to vary the SNR of digital data streams to measure changes in BER. This receiver stress testing serves to establish the jitter budget for high speed data systems. Figure 5 illustrates the type of edge, or transition movement created by AM and PM jitter injection.

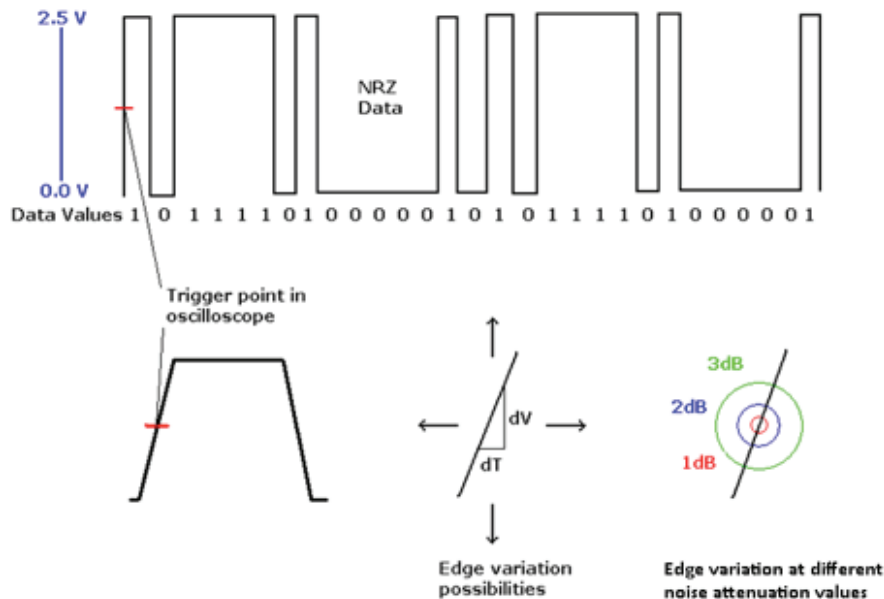
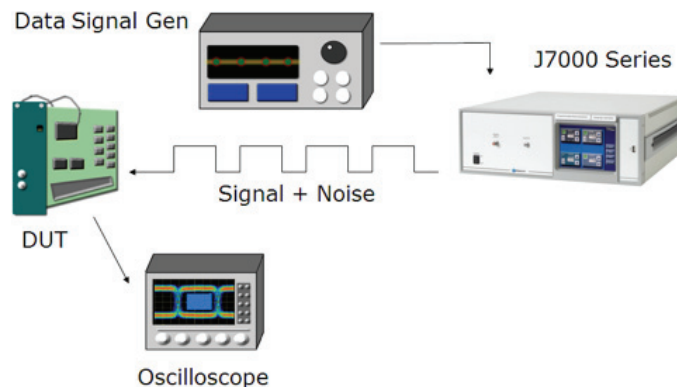

Figure 5.

Noisecom can provide several noise injection models for your Jitter testing requirements. These range from the J7000A series remote control instrument to an NC1000 series module for assembly into integrated Jitter testing systems.

Figure 6. A typical system diagram with the Noisecom J7000A single-board computer injecting noise onto a data stream for stressed receiver Jitter testing.



Antenna Reference Sources

All objects emit white noise in an amount proportional to their temperature and the radiometer is a sensitive calibrated receiver that can be used to measure these temperatures remotely for distant objects like stars and galaxies. If the noise power from the object is captured at the input antenna of a radiometer, it can be compared to the noise power of an internal white noise reference source instead of another star, or open dark sky used by more common radiometer types. The noise-injection radiometer has significant advantages because it eliminates measurement errors due to gain variation, radiometer noise figure, and impedance mismatching. A block diagram of the noise-injection radiometer concept is shown in Figure 7.

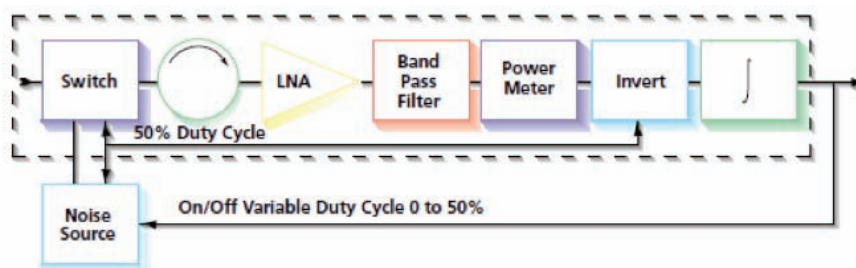

Figure 7: Noise-injection Radiometer

The noise temperature of interest is the effective noise temperature at the radiometer

input, which is: $T_{in} = T_a (1 - |\Gamma_s|^2)$

where: T_a = the available noise temperature

$|\Gamma_s|$ = the source reflection coefficient

The effective noise temperature is compared with two internal reference temperatures in the noise-injection radiometer. Gain variations and the noise figure of the radiometer can thereby be estimated and deducted. If one of these reference noise temperatures is equal to the physical temperature of the receiver front end, the reflection coefficient term for this reference temperature becomes negligible. The reflection term can be neglected because the noise power reflected from the reference source is equal to that reflected from the front end if both have the same temperature. A good solid-state white noise source with high efficiency, such as from Noise Com's NC346 or NC5000 Series, has these properties when it is in the "Off" condition. The second internal reference temperature is obtained when the noise source is in the "On" condition. This noise temperature can be determined from the ENR of the noise source as follows: $ENR = 10 \log ([T_a (1 - |\Gamma_s|^2) - 290] / 290)$

In the noise-injection radiometer, the noise power of the white noise source in the "Off" condition is measured during one-half period. The input noise power plus the noise power of the white noise source in the "On" condition is measured during the other half period. The duty cycle of alteration between the input noise power and the noise power of the white noise source in the "On" condition is controlled by a feedback loop. The loop keeps the average noise power equal to the noise power measured during the first half period. The measurement of input noise power therefore becomes a measurement of time (duty cycle) rather than power (see Figure 2).

Figure 2. Noise-injection Radiometer
Duty-Cycle



The sensitivity of the noise-injection radiometer is close to that of the Dicke radiometer:

$$T = 2 \sqrt{(T_{off} + T_n) / (B \times t)}$$

where: **T** = sensitivity (resolution)
T_{off} = first reference noise temperature
T_n = radiometer noise temperature
B = radiometer noise bandwidth
t = integration time

Noise Com's NC346 Series coaxial and NC5000 Series waveguide white noise sources are available with optional built-in regulators for stable noise-injection radiometer applications.

Diode

Noisecom's noise diodes are the fundamental building blocks of our noise systems. They are hand-picked for performance characteristics that make them ideally suited for broadband noise generation with a flat frequency response. Noisecom noise diodes can deliver symmetrical white Gaussian noise and flat output power versus frequency if inserted into the proper biasing circuit. The diodes are available in a wide variety of package styles, but special package configurations or screening processes are available upon request. The NC100 and NC200 Series diodes are designed for audio and RF applications. The NC300 and NC400 Series diodes are designed for microwave applications in which a 50-ohm impedance is required. Typical small signal impedance of the NC300 and NC400 Series is 10-20 ohms after a diode is biased. Figure 9 is an example bias circuit that can be used as a starting point for a noise generating source. A typical noise diode, properly biased will produce higher power output at lower frequencies, but drop as the frequency increases. The example includes typical resistor and capacitor values for experimentation and Noisecom is not responsible for circuit design issues with our diodes. The catalog lists possible frequency ranges for different diodes, but the final output will be dependent upon the user's bias circuit and any additional amplification circuitry.

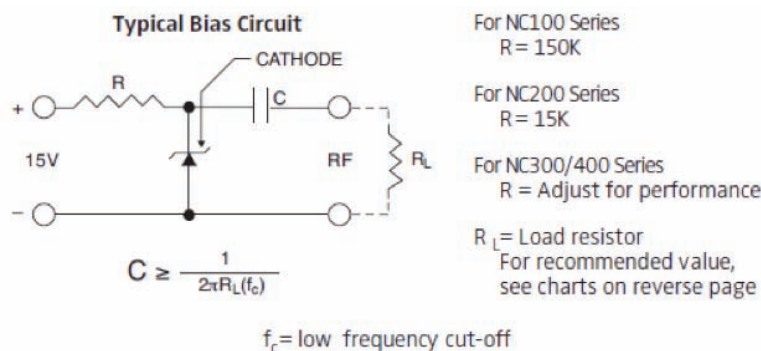

Figure 2.

Example Calculations of Specific Noise Parameters

What is total power in dBm if my noise bandwidth is 1 MHz to 2 GHz with a desired power spectral density
PSD = -90 dBm / Hz?

Total power formula: dBm = dBm / Hz + 10log(noise BW)
 Total power (dBm) = -90 dBm / Hz + 10log(2e9 Hz)
 Total power (dBm) = -90 + 93 = 3 dBm

What is the ENR (Excess Noise Ratio) for a module having -130 dBm / Hz?

PSD (dBm/Hz) = - 174 dBm / Hz + ENR
 ENR (dB) = 174 dBm / Hz – PSD (dBm / Hz)
 ENR (dB) = 174 dBm / Hz – 130 dBm / Hz
 ENR (dB) = 44 dB

Who We Are

Wireless Telecom Group is a global designer and manufacturer of radio frequency (“RF”) and microwave-based products for wireless and advanced communications industries. We market our products and services worldwide under the Boonton Electronics (“Boonton”), Microlab/FXR (“Microlab”) and Noisecom brands. Our Brands and products have maintained a reputation for their accuracy and performance as they support our customers’ technological advancements within communications. We offer our customers a complementary suite of high performance instruments and components meeting a variety of standards including peak power meters, signal analyzers, noise sources, power splitters, combiners, diplexers, noise modules and precision noise generators. We serve commercial and government markets within the satellite, cable, radar, avionics, medical, and computing applications. We are headquartered in Parsippany, New Jersey, in the New York City metropolitan area and we maintain a global network of Sales offices dedicated to providing excellent product support.

Wireless Telecom Group, Inc. continuously targets opportunities that allow us to capitalize on our synergies and our talents. Our technological capabilities along with our customer service strategies remain essential competencies for our success.

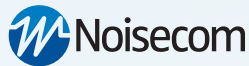

Noisecom is a global provider of electronic noise generation equipment and noise sources in the commercial and military telecommunications fields. Utilized for accurate, reliable measurements, users look to Noisecom for specialized assistance with their equipment design.

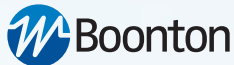

Boonton Electronics, a wholly owned subsidiary, is a leader in the manufacture of test equipment dedicated to measuring the power of RF and Microwave systems used in multiple telecommunication markets. A pioneer in the industry, Boonton continues to provide high quality and high value instruments for users backed with outstanding customer support.



Microlab, a wholly owned subsidiary, is a global provider of passive microwave components including power splitters, directional couplers and filters. These products are employed as system components in commercial applications such as wireless base stations for cellular, paging and private communications, in-building wireless signal distribution, television transmitters and aircraft navigation landing systems. Microlab products are also used in military systems such as electronic countermeasures and missile guidance.